



Self Service

Electrolux Self Service:

The new **Electrolux Self Service** blends in perfectly with the leading lines of the Electrolux brand- A Specialist in combined solutions:

- Innovative technology
- Reliability guaranteed

• Optimum performance and excellent solutions to satisfy the most demanding customers.

The new **Electrolux Self Service** is the right choice for achieving something unique, both in terms of performance and design.



flexibility and reliability in an exclusive design

A customized line

Thanks to its **modularity** and the large number of models available.

Food Quality

The **Coltemp System** is for keeping the glass display unit temperature constant, guaranteeing the highest quality of the foods displayed.

Food Visibility

Thanks to the design of the glass surfaces and the lighting system in all the units.

Reliability

A completely **304 AISI** steel structure with **20/10** thick tops and electronic **Smart** (HACCP) button for the refrigerated units.

Ergonomics

Easy and direct interaction between the customer and the operator.
Versatile work surfaces that are suitable for the operator's requirements.

Cleanliness Guaranteed

Thanks to the single top ("**end to end**" connection), the rounded corners and the pull-out glass panels.

Extremely easy installation

Innovative "Click-in" system for the connection of units.
Rapid attachment of front panels and plinths.

Global safety

All units are **NF** (Afnor-France) certified, guaranteed hygiene with very easy cleaning.

NF HYGIENE ALIMENTAIRE

certifying authority:
AFAQ AFNOR Certification
11, Avenue Francis de Pressense
93571 Saint-Denis La Plaine Cedex - France

HYGIÈNE ALIMENTAIRE

conformity with regulation **NF031**
certified guarantees: **fitness for cleaning, thermal performance**

Electrolux: the solution,



- **A customized line**

The new Electrolux Self Service offers a unique design, which allows different ways of personalizing this line.

The various combinations of materials: cherry or neutral panels to be tinted, and shapes: flat or curved panels, allow everyone to create a unique line, which is perfectly in tune with personal space and requirements.

- **Food quality and visibility**

The high quality of the materials used, the completeness of its components and the innovative contents of Electrolux Self Service give the professional caterer the certainty of being able to welcome his clientele in surroundings of high quality design, aesthetic appeal and maximum functionality. Furthermore, all the functions guarantee perfect visibility and display of foods and easy access for the consumer.



the safety and the ecology

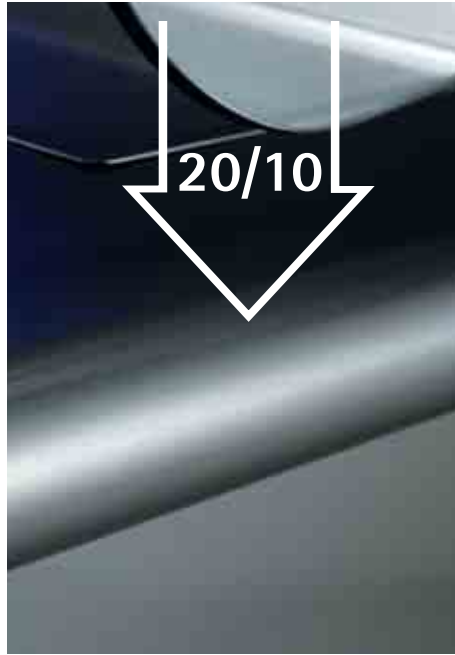

- **Easy cleaning and hygiene guaranteed**

- "End-to end" connection between the modular units to guarantee perfect joints, which are easy to clean and also reliable
- Pressed wells with rounded corners
- Internal units in heated cupboard without joints and with completely rounded corners
- Glass display units and Shelves in easily removable glass

- **Global safety**

Refrigerated units with electronic Smart that includes a HACCP button, which allows monitoring and memorization of all alarms and critical events 24 hours a day

- **Energy saving and ecology**

Considerable energy saving, with just as much care taken to make it ecologically friendly, is guaranteed by the use of high density foamed polyurethane (50 mm thick), obtained with 100% cyclopentane gas (CFC and HCFC free) and the use of a R134a refrigerant for the cold units

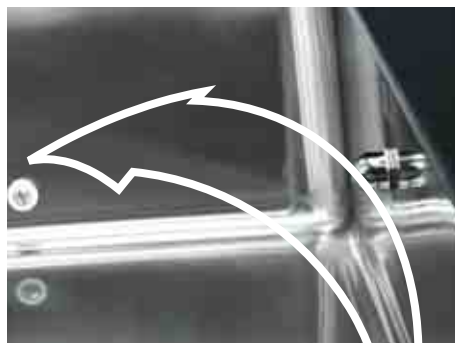

Hot Units

- The range of hot units includes the following appliances:
 - bain-marie on heated cupboard or bridge-type (dry models also available)
 - heated cupboards with neutral tops
 - hot tops in tempered glass on heated cupboard or bridge-type















• **Front Cooking**

It offers the opportunity to cook dishes on the spot directly in front of the customer. The units consist of 2 steel shelves: one suitable to contain the top functions of the 700 line (modular cooking) and the other – placed underneath – for the kitchen tools.

They are also provided with front protection glass, which guarantees perfect visibility for the customer, while maintaining maximum hygiene and safety.



• **Electronic Hot Units**

- | | | |
|--|--|---|
|  <p>On/Off button</p> |  <p>HACCP button
Monitoring and memorization of all alarms/critical events</p> |  <p>Bain-marie well temperature
Well temperature display button</p> |
|  <p>Machine under voltage</p> |  <p>Temperature control
Increase button</p> |  <p>Ceramic glass top settings
Left zone control button</p> |
|  <p>Self-diagnosis button
To monitor and display error messages and switch off the acoustic alarm</p> |  <p>Decrease button</p> |  <p>Right zone control button</p> |
| | |  <p>Cupboard temperature
Set point control button for heated cupboard temperature</p> |

Cold Units

• The range of cold units includes the following appliances:

- Refrigerated glass display units with top on refrigerated cupboard or bridge-type

- Refrigerated glass display units with well on refrigerated cupboard or bridge-type

- Refrigerated cupboards with top or well

- Refrigerated wells - bridge-type



• Why Smart?

The control panel of the refrigerated units is connected with a maximum of 5 probes (2 for the bridge-type units, 4 for the units on refrigerated cupboard and 5 for the glass display units). The probes are placed between cupboards, glass display units and the condenser to monitor the respective temperatures.

In the event of a probe not working, the optimum temperature for conservation is, however, maintained, as the Smart system is able to memorize and maintain operating conditions.

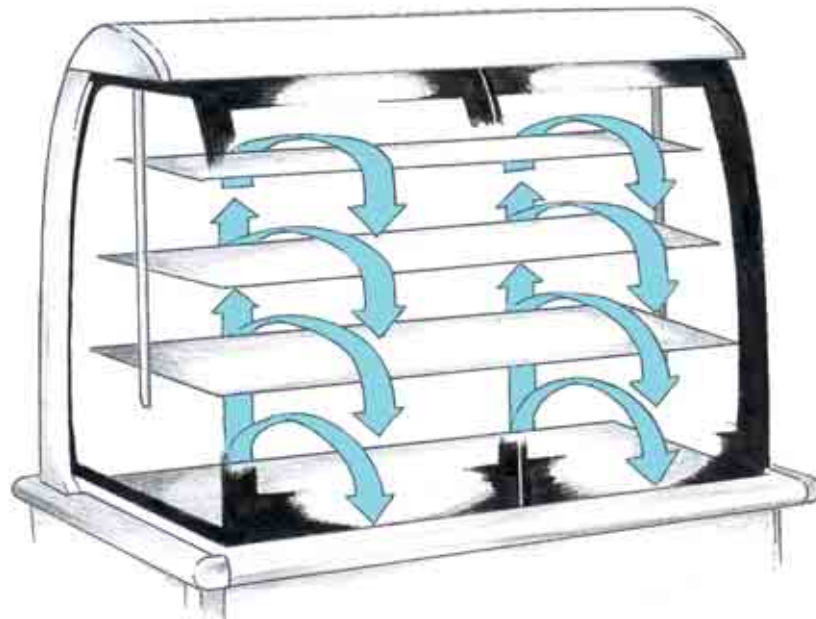

• Coltemp System

Perfectly kept food

Cold air circulation along the outer perimeter of the glass display unit and under the shelves, to avoid drying of displayed food









Temperature guaranteed

Thanks to the optimum performance of the glass display unit and the well, which perfectly conform to the French NF norms

Hygiene guaranteed

Thanks to the absence of air channels

• Electronic Cold Units

- | | | |
|--|---|---|
|  On/off button |  Temperature increase and activation of the manual defrosting cycle |  Self-diagnosis button
To control and display the error messages and switch off the acoustic alarm |
|  Compressor in operation |  Temperature decrease |  Glass display unit temperature
Ignition and adjustment of glass display unit temperature set point |
|  Machine in operation |  Cupboard temperature
Ignition and adjustment of cupboard temperature set point | |
|  HACCP button
Monitoring and memorization of all alarms/critical events | | |

Neutral Units

The new range of Neutral elements consist of units with top on cupboard or bridge-type.

The top (20/10 thick) can be used as food display, while the cupboard as kitchen utensils storage.



• **End component (available in 2 models-right and left):**

- a side panel in cherry or stainless steel (available with or without plinth)
- an end cover for the worktop
- an ABS half moon shell to cover the sides of the hood
- an ABS covering shell for superstructure upright (outer part)



• **End component (available in 2 models-right and left):**

- a semi-circular side panel in cherry with stainless steel top and side plinth
- an ABS half moon shell to cover the sides of the hood
- an ABS covering shell for superstructure upright (outer part)

Available a version with stainless steel top equipped with dish lowerator (25 dishes up to maximum diameter 255 mm)

Complementary components

Bread rack with front element for trolleys



- The **bread rack component** consists of:
- bread dispenser with cover and door in transparent Plexiglas
 - cutlery dispenser provided with a special mechanism to make loading and unloading of cutlery into the various compartments easier
 - tempered glass lower shelf that can be used for napkins or glasses

The **front element for trolleys** has been designed to create a space, on the operator's side, for placing trolleys up to 710 mm.

Bread, tray, glass and cutlery rack island unit



- Available in 3 different models:
- cutlery, tray and bread dispenser, 860 mm (1-section island unit)
 - cutlery, tray and bread dispenser (in baskets), 860 mm (1-section island unit)
 - cutlery, tray and bread dispenser with 8 shelves for glasses, 1670 mm (2-section island unit)

Corner units



Available in 3 different models:

- an internal/external 45° corner unit: it can be installed as an internal corner unit (with the shortest side facing the customer) or as an external corner unit (with the longest side facing the customer)
- a 90° internal corner unit: it should be installed as an internal corner unit (with the shortest side facing the customer) and it is provided with a bottom shelf
- a 90° external corner unit: it should be installed as an external corner unit (with the longest side facing the customer) and it is provided with a bottom shelf

Cashier's unit



Cashier's component with a Bridge section that is open on the operator's side, supplied with a small drawer and key and electric socket.

The customer choice



Gantry

The Gantries are made of 304 AISI stainless steel and special non-toxic material suitable for contact with food.

They can be provided with a stainless steel shelf with protection or with one or two glass shelves with protection. They can also be supplied with hot or cold lights according to their use.

Tray slides



- Tubular steel

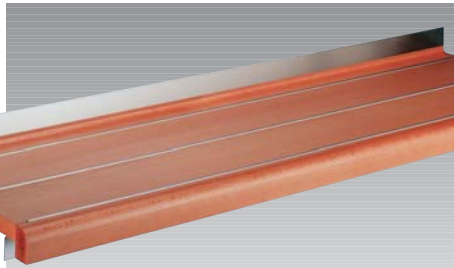

- Wood

Front Panels



- Straight cherry panels



- Curved cherry panels

Stainless steel plinth base



- Stainless steel front panel

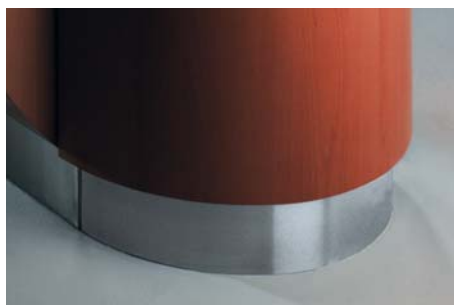

- Curved or corner (45° and 90°) in stainless steel

Functional units



- 1** Cashier's unit
- 2** Refrigerated glass display unit
- 3** 90° internal corner unit
- 4** Front cooking unit
- 5** Bain-marie
- 6** Gantry with 1 stainless steel shelf and hot lights
- 7** 45° corner unit
- 8** Bread dispenser with front element for trolleys

Accessories for personalization

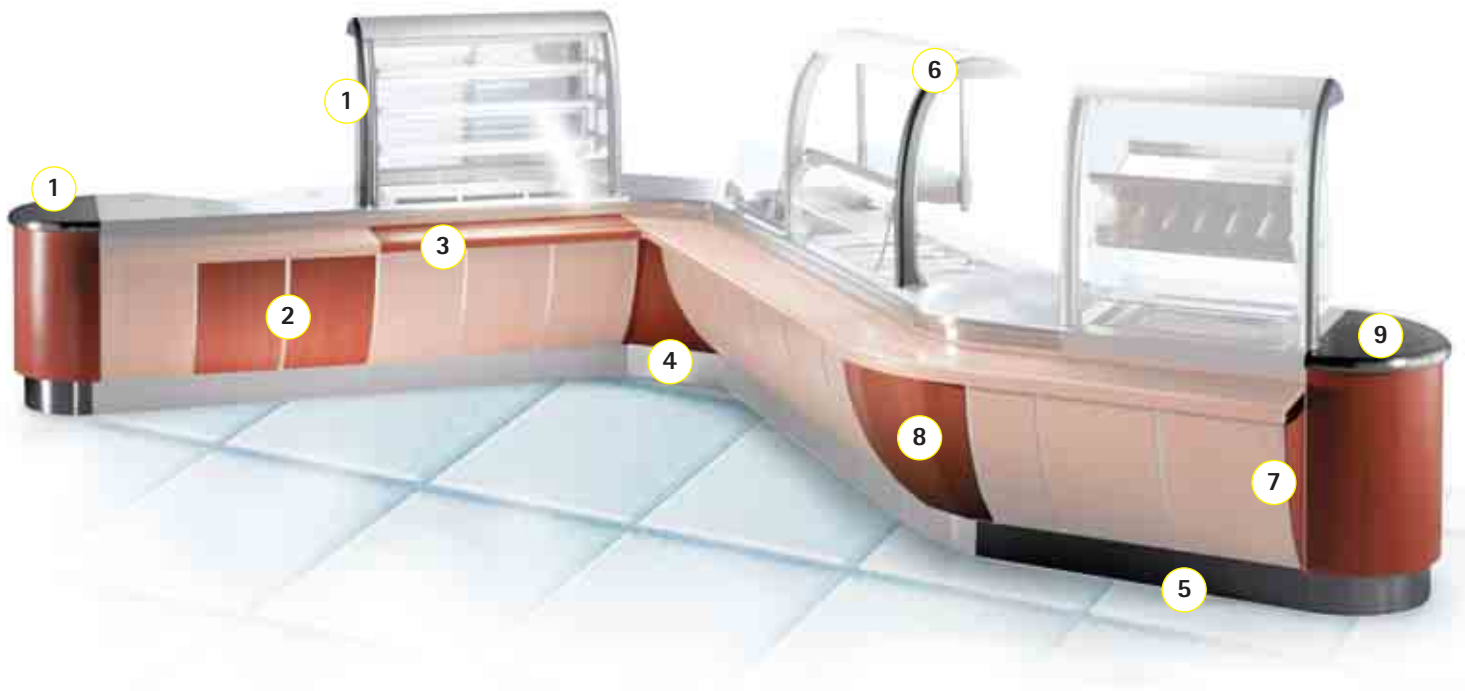

- 1** Left end unit
- 2** Kit comprising 2 curved front panels in cherry, 400mm
- 3** Cherry tray slide: available in 4 standard lengths (2, 3, 4 and 6 GN)
- 4** Curved front panel in cherry for internal 90° corner unit
- 5** Steel plinth base: available for all units, both on the customer's and the operator's sides.
- 6** Pair of covering shells for the gantry (to close the gantry at the sides, when the adjacent units are without)
- 7** Cherry side panel (to close the sides of curved front panels)
- 8** Curved front panel in cherry for external 45° corner unit
- 9** Right end unit

Layout

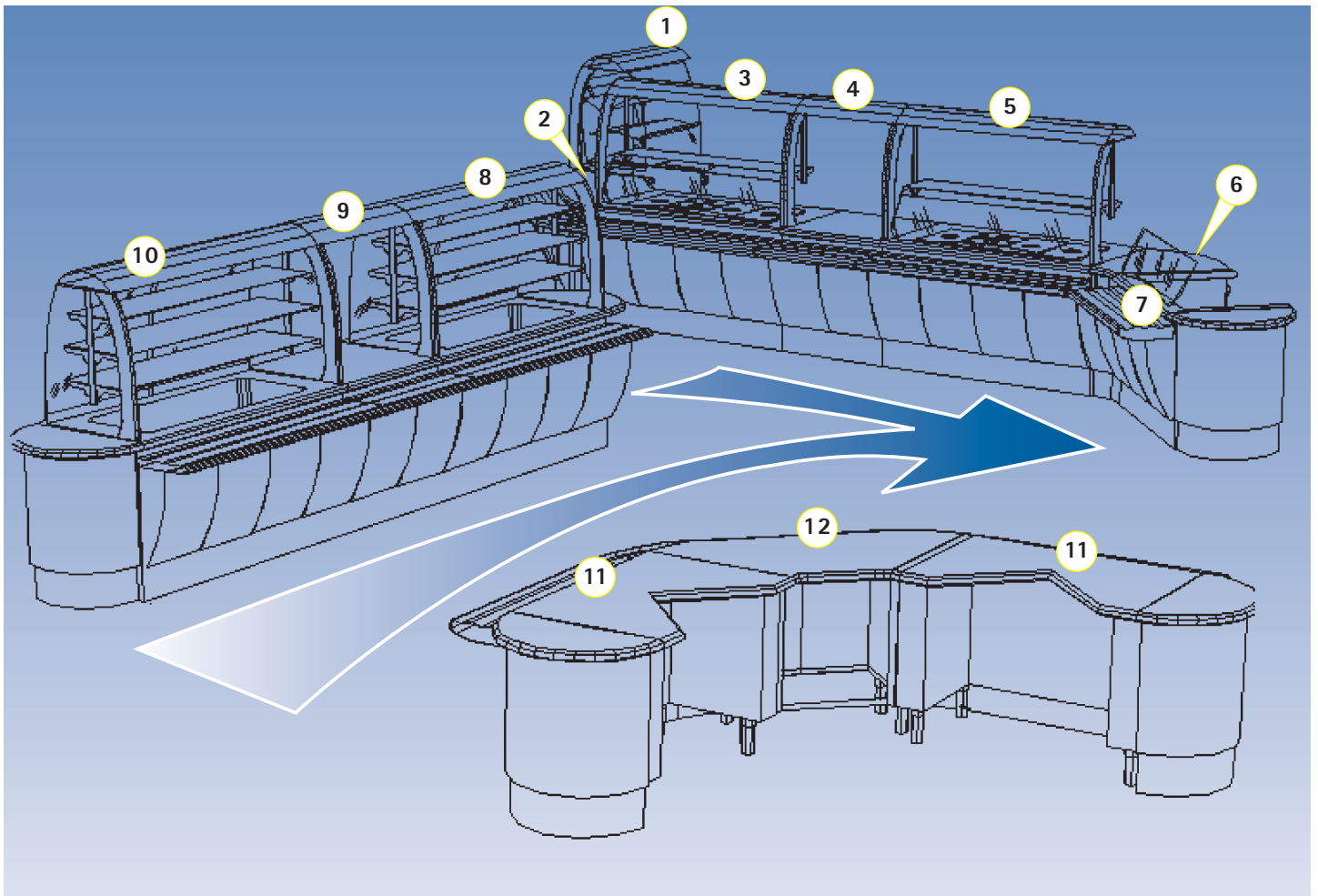

- 1. Cutlery bread dispenser with tray lowerator trolley
- 2. 90° external corner unit with stainless steel top
- 3. Bain-marie 4 GN on heated cupboard with Gantry with one stainless steel shelf, heating lights and sneeze-guard
- 4. Neutral cupboard with stainless steel top with Gantry without shelf
- 5. Bain-marie 4 GN on heated cupboard with Gantry with one stainless steel shelf, heating lights and sneeze-guard

- 6. 45° internal corner unit with stainless steel top
- 7. Front cooking unit with sneeze-guard
- 8. Refrigerated open display unit 4 GN with refrigerated well and cupboard (service curtain included)
- 9. Neutral cupboard with stainless steel top with Gantry without shelf
- 10. Refrigerated open display unit 4 GN with refrigerated well and cupboard (service curtain included)
- 11. Cashier unit

- 12. 90° external corner unit with stainless steel top

Accessories:

- Cherry wood tray-slide
- Cherry wood curved panels
- Stainless steel kicking strip
- Round end elements

Layout

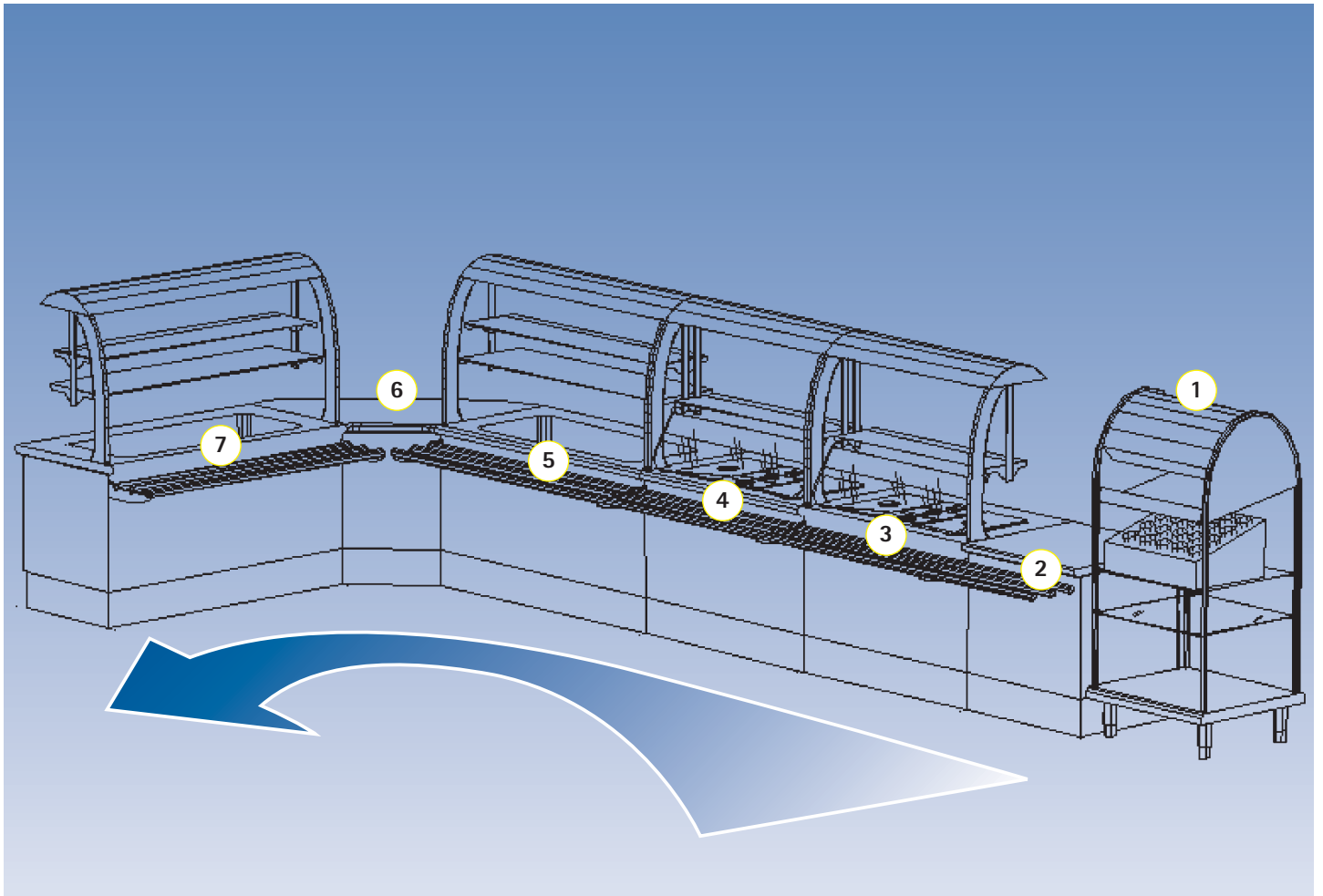

- 1. Island unit for trays, cutlery and bread
- 2. Neutral cupboard with stainless steel top
- 3. Bain-marie 3 GN, bridge-type with Gantry with one stainless steel shelf, heating lights and sneeze-guard
- 4. Bain-marie 3 GN, bridge-type with Gantry with one stainless steel shelf, heating lights and sneeze-guard

- 5. Cold unit 4 GN with refrigerated well, bridge-type with Gantry with two glass shelves and cold lights
- 6. 90° internal corner unit with stainless steel top
- 7. Cold unit 3 GN with refrigerated well, bridge-type with Gantry with two glass shelves and cold lights

Accessories:

- Tubular tray-slide
- Straight stainless steel panels (already included in the modules)
- Stainless steel kicking strip
- Straight end elements

BUILDING THE future

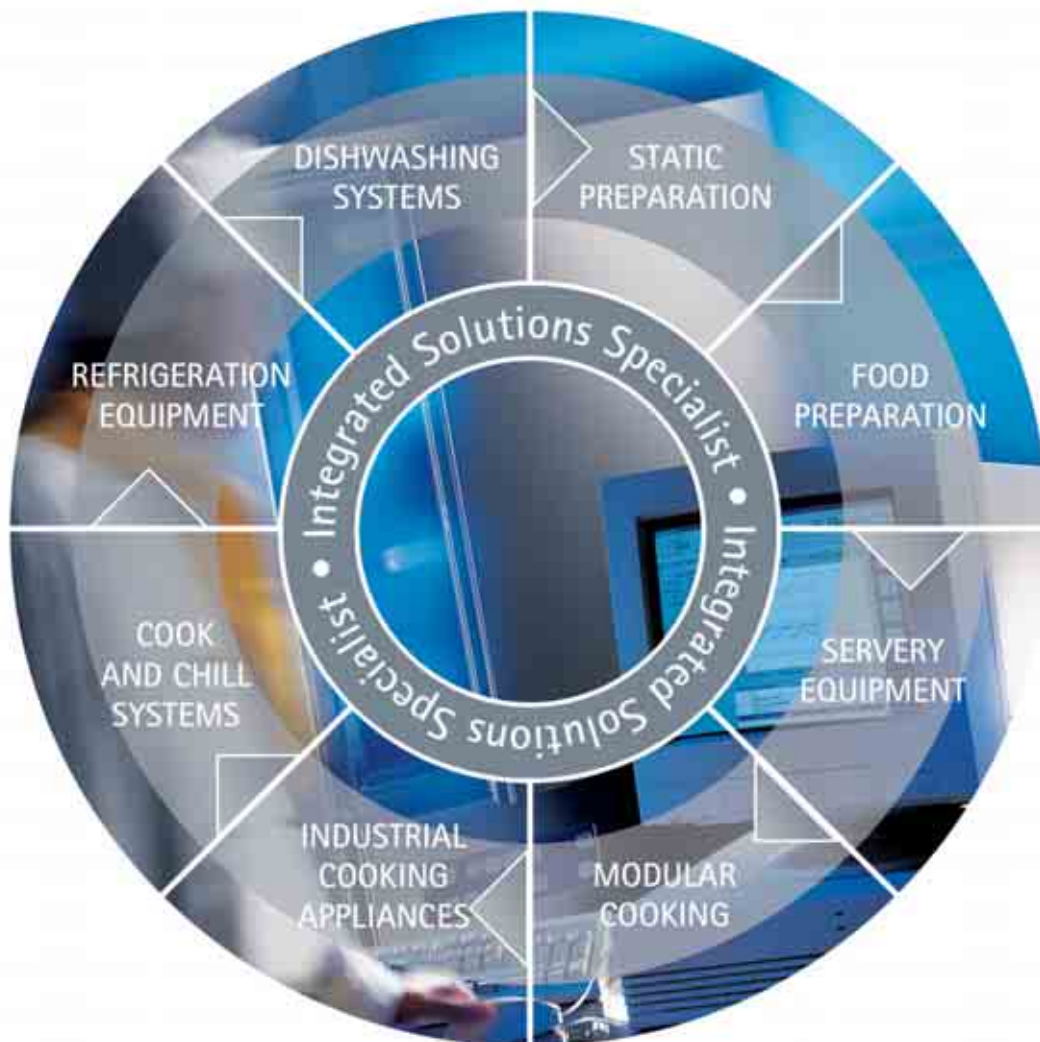

 **Electrolux**

www.electrolux.com/foodservice

Share more of our thinking at www.electrolux.com